

FEATURES

- 2A and 2C configurations
- 5A,8A contact capacity
- 5KV dielectric strength from coil to contacts
- UL and CUL approval, File No.: E179936
- TUV approval File No.: R50154187

CONTACT DATA

Contact form	2 A ; 2 C
Contact resistance (Initial)	100mΩ (voltage drop at 1A 6VDC)
Carrying current	Cos Φ = 1
ME-12C	5A/250VAC ; 5A/30VDC
ME-12C-8	8A/250VAC; 5A/30VDC
Max. switching capacity	ME-12C: 2000VA , 240W ME-12C-8: 1250VA , 240W
Max. switching current	8A
Max. switching voltage	250VAC, 30VDC
Inductive Load	1A 240VAC
Contact material	Silver Alloy

CHARACTERISTICS

Insulation resistance	100MΩ at 500VAC
Dielectric strength	5000VAC, 1 min. between coil to contacts 1000VAC, 1 min. between open contacts
Operate time	Max. 20 ms (nominal voltage)
Release time	Max. 10 ms (nominal voltage)
Vibration resistance	10-55Hz at double amplitude of 1.5mm
Shock resistance	10G
Humidity	Max. 85% RH
Ambient temperature	- 30°C to + 70°C
Life expectancy	
- Electrical	1 × 10 ⁵ operations
- Mechanical	1 × 10 ⁷ operations

COIL SPECIFICATIONS (540mw)

Nominal voltage (VDC)	Pick-up voltage (VDC)	Drop-out voltage (VDC)	Nominal current (mA±10%)	Coil resistance (Ω±10%)	Power consumption(mW)	Max. allowable voltage (VDC)
3	2.4	0.15	180	17	540	130% of nominal voltage
5	4	0.25	108	46	540	
6	4.8	0.3	90	67	540	
9	7.2	0.45	60	150	540	
12	9.6	0.6	45	270	540	
24	19.2	1.2	22.5	1050	540	
48	38.4	2.4	11.2	4250	540	

COIL SPECIFICATIONS (720mW)

Nominal voltage (VDC)	Pick-up voltage (VDC)	Drop-out voltage (VDC)	Nominal current (mA±10%)	Coil resistance (Ω±10%)	Power consumption(mW)	Max. allowable voltage (VDC)
3	2.4	0.15	240	13	720	130% of nominal voltage
5	4	0.25	144	35	720	
6	4.8	0.3	120	50	720	
9	7.2	0.45	80	110	720	
12	9.6	0.6	60	200	720	
24	19.2	1.2	30	800	720	
48	38.4	2.4	15	3200	720	

ME-12C

MASSUSE RELAY

COIL SPECIFICATIONS (240mW)

Nominal voltage (VDC)	Pick-up voltage (VDC)	Drop-out voltage (VDC)	Nominal current (mA±10%)	Coil resistance (Ω±10%)	Power consumption(mW)	Max. allowable voltage (VDC)
3	2.4	0.15	80	38	240	130% of nominal voltage
5	4	0.25	48	104	240	
6	4.8	0.3	40	150	240	
9	7.2	0.45	26.7	338	240	
12	9.6	0.6	20	600	240	
24	19.2	1.2	10	2400	240	
48	38.4	2.4	5	9600	240	

ORDERING INFORMATION

ME-12C - 012 - Z S T M 8

Model No.	Coil Voltage	Contact Form	Protection	Contact Material	Power consumption	Rating
ME-12C	3, 5, 6, 9, 12, 18, 24, 48 or 60VDC	H: 2 A Z: 2 C	Nil: Flow solder type S: Sealed type	Nil: AgCdO T: AgSnO ₂	Nil: 540mW M: 240mW (only for 5A rating) D: 720mW	Nil: 5A 8: 8A

DIMENSIONS (UNIT: mm)

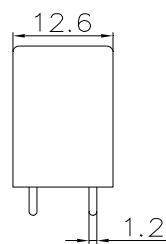
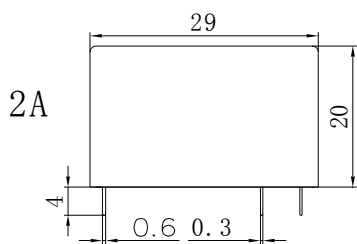
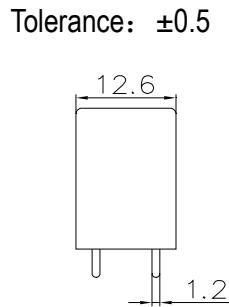
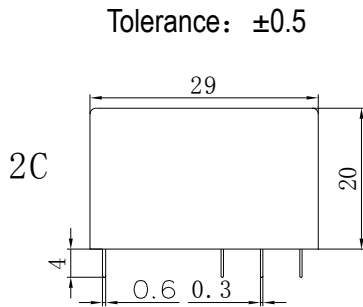

Bottom View

Tolerance: ±0.1

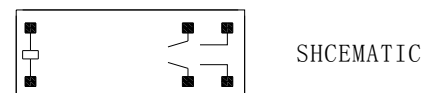
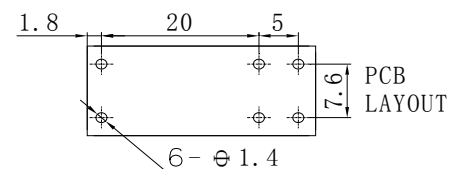
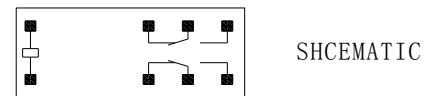
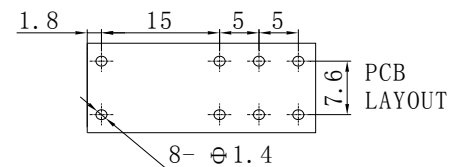

Disclaimer: All the specifications are subject to change without notice.